

Overdenture Laboratory Technique with Super Snap

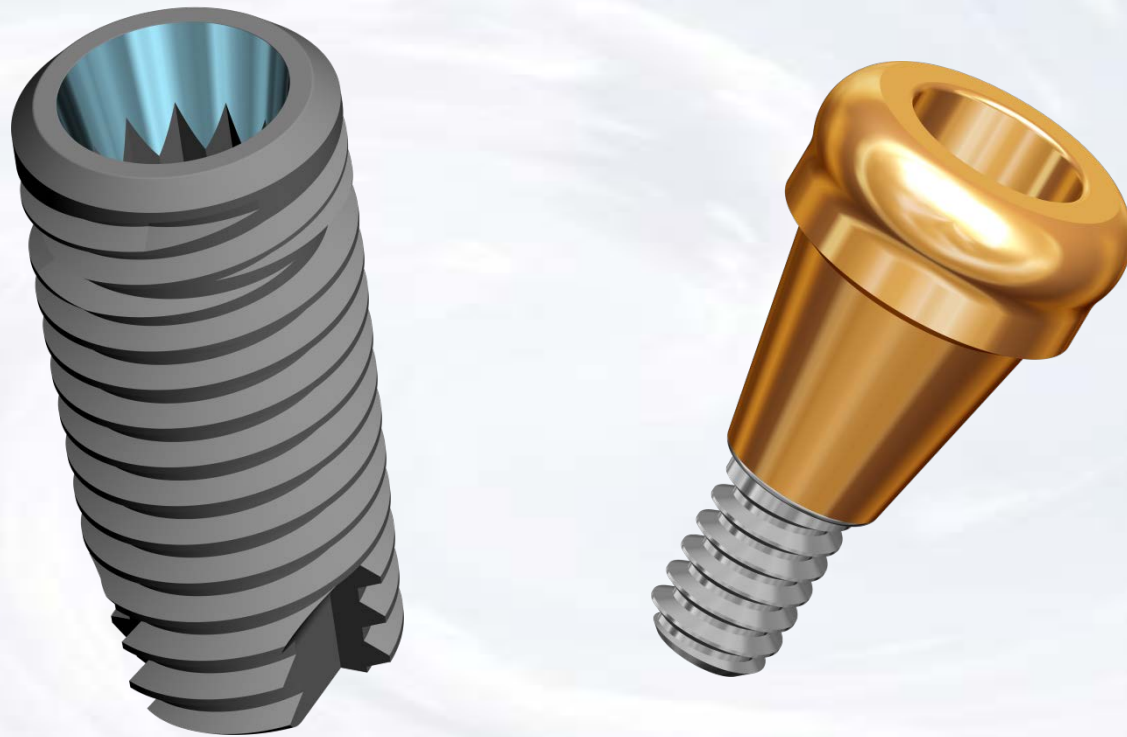

Blue Sky Bio

Overdenture Laboratory Technique with Super Snap

Assemble screw driver with
Thumb Knob

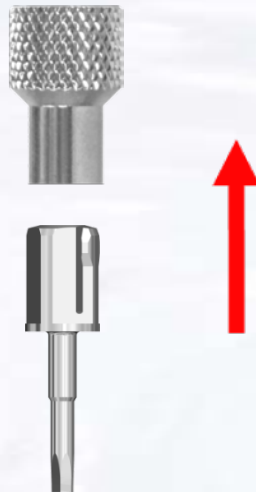

Remove healing abutment
from implant

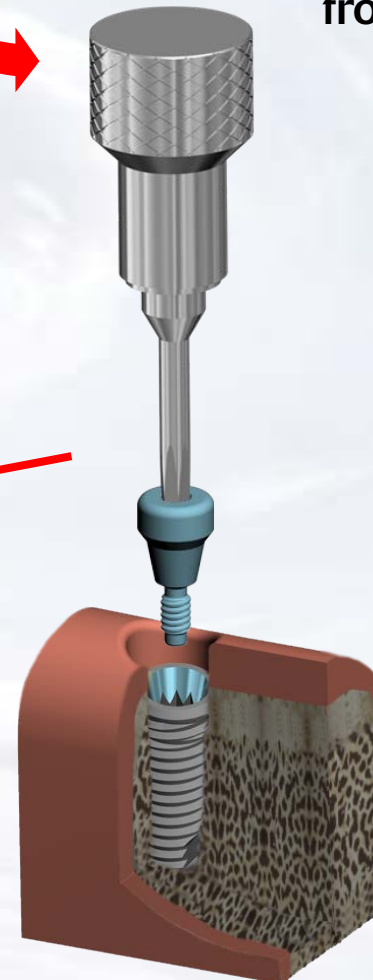

Blue Sky Bio

Overdenture Laboratory Technique with Super Snap



Blue Sky Bio

Overdenture Laboratory Technique with Super Snap



Insert the Hex Driver within the 30Ncm torque ratchet

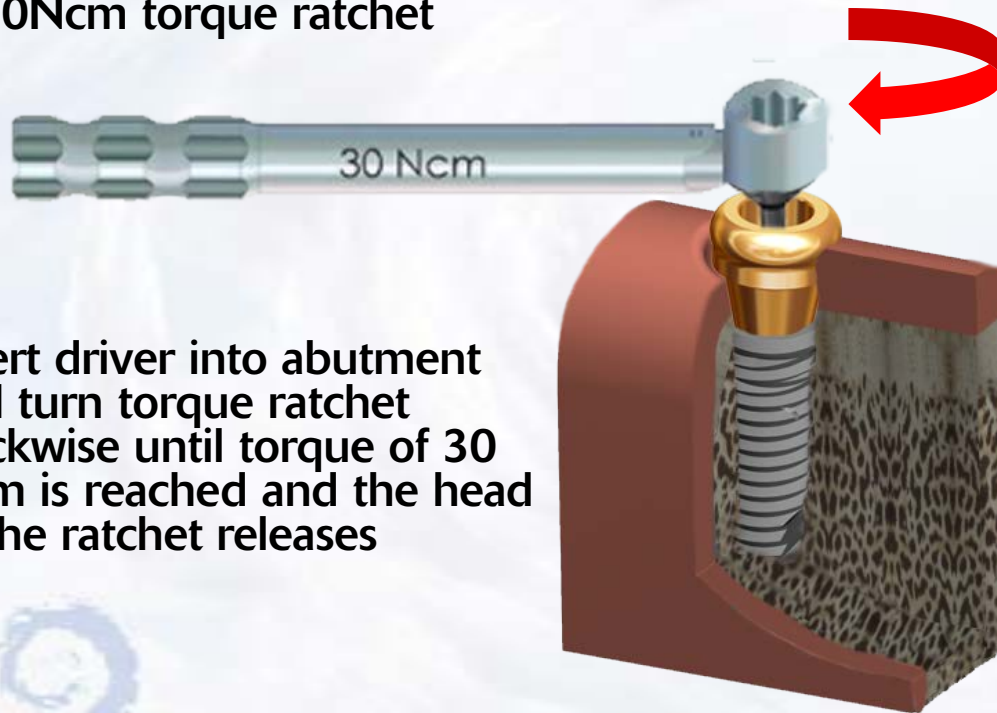

Insert driver into abutment and turn torque ratchet clockwise until torque of 30 Ncm is reached and the head of the ratchet releases

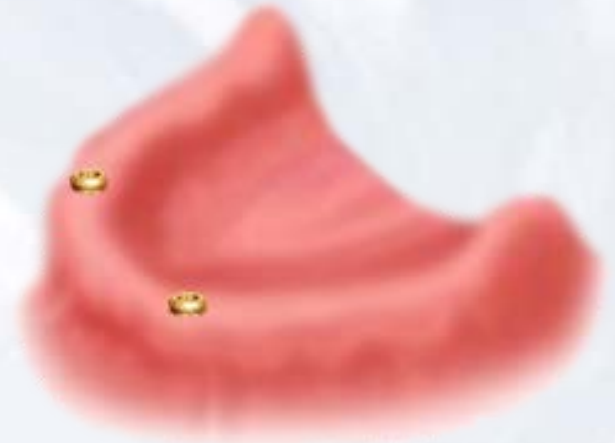

Abutments in place



Blue Sky Bio

Overdenture Laboratory Technique with Super Snap

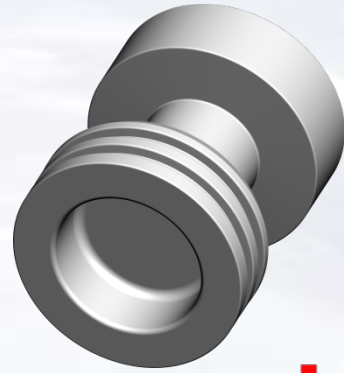

Snap impression transfer
on the abutments

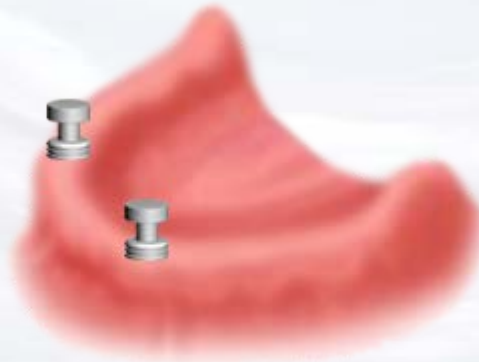

Blue Sky Bio

Overdenture Laboratory Technique with Super Snap

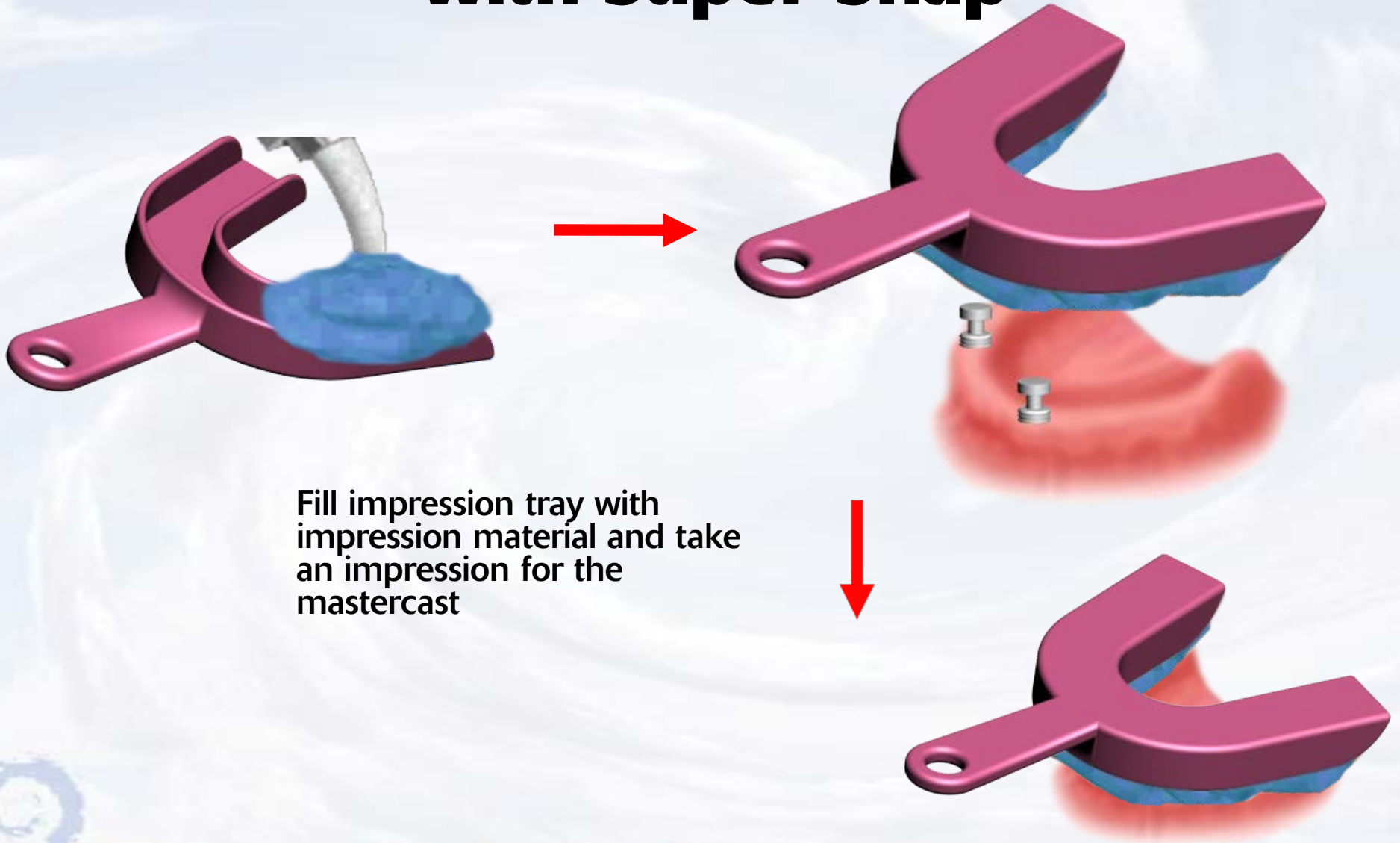

Blue Sky Bio

Overdenture Laboratory Technique with Super Snap



After impression material has set remove impression from mouth picking up the impression transfers

Snap analogs into the impression transfers



Blue Sky Bio

Overdenture Laboratory Technique with Super Snap



Pour impression with model stone and make master cast with analogs in place



Blue Sky Bio

Overdenture Laboratory Technique with Super Snap



Put yellow insert on the
analog



Blue Sky Bio

Overdenture Laboratory Technique with Super Snap



Process the denture



Blue Sky Bio

Overdenture Laboratory Technique with Super Snap (Optional)



Remove the insert you want to change with the sharp point of the removal instrument

Place the insert with the desired retention into the denture with the opposite side of the removal instrument



Blue Sky Bio